

REVISIONS	DATE

CITY OF LITTLE ROCK, ARKANSAS  
ROSE CREEK TRAIL  
COVER SHEET

DEPARTMENT OF PUBLIC WORKS  
CIVIL ENGINEERING  
701 W. MARKHAM  
LITTLE ROCK, ARKANSAS 72201

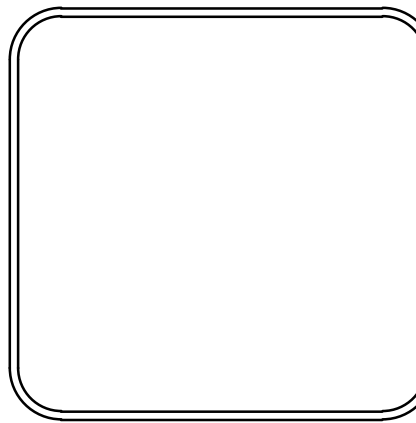

DRAWN BY  
AS  
DESIGNED  
AT  
CHECKED  
BAP  
DATE  
02-19-2024  
SCALE  
PROJECT NO.  
SHEET NO.  
C1

30% SUBMITTAL

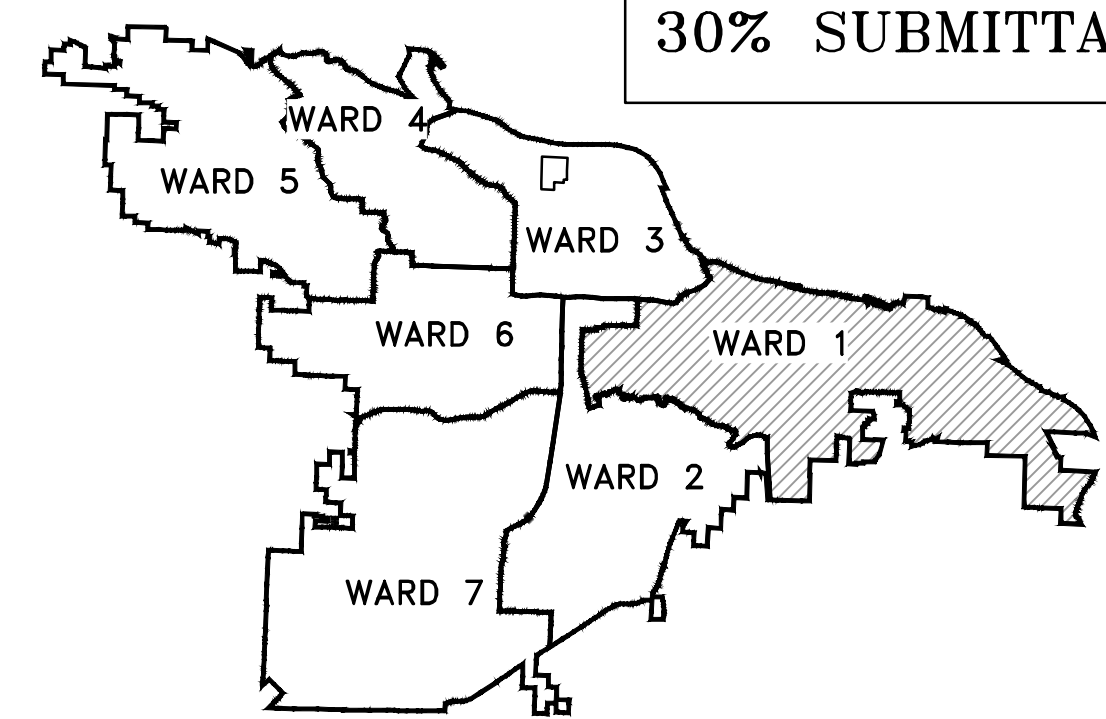

PROJECT LOCATION - WARD 1

# ROSE CREEK TRAIL

(FROM 3RD ST. TO CANTRELL RD./  
GILL STREET OVERPASS)

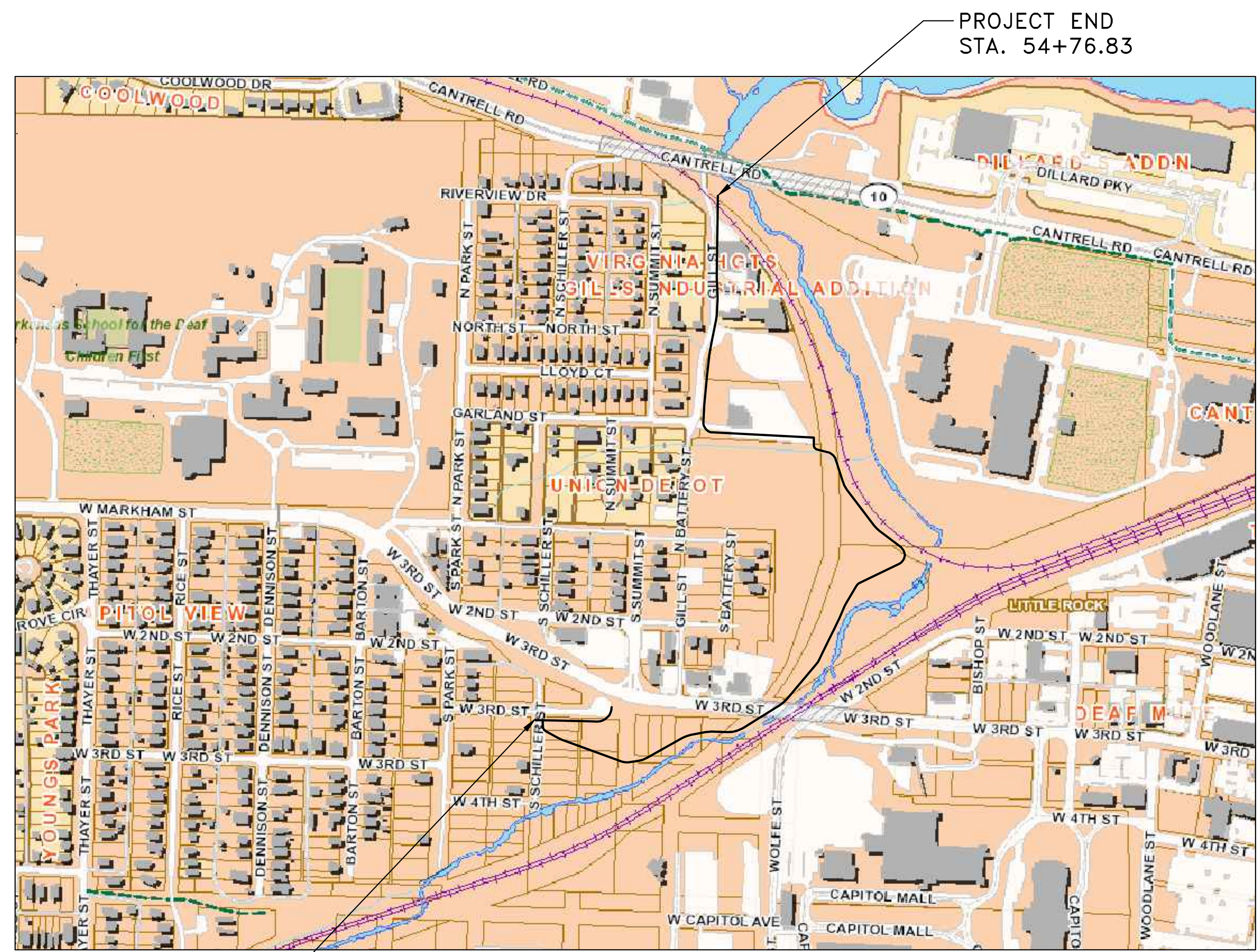

PROJECT END  
STA. 54+76.83

PROJECT START  
STA. 20+00.00

### LOCATION

DEPARTMENT OF PUBLIC WORKS  
CIVIL ENGINEERING  
701 WEST MARKHAM STREET  
LITTLE ROCK, ARKANSAS 72201

### Sheet List Table

Sheet Number	Sheet Title
C1	COVER SHEET
C2	LEGEND & QUANTITIES SHEET
C3	TYPICAL SECTIONS SHEET 1
C4	TYPICAL SECTIONS SHEET 2
C5	OVERALL SITE SHEET
C6	SITE ENLARGEMENT SHEET 1
C7	SITE ENLARGEMENT SHEET 2
C8	SITE ENLARGEMENT SHEET 3
C9	ROSE CREEK TRAIL PLAN & PROFILE SHEET 1
C10	ROSE CREEK TRAIL PLAN & PROFILE SHEET 2
C11	ROSE CREEK TRAIL PLAN & PROFILE SHEET 3
C12	ROSE CREEK TRAIL PLAN & PROFILE SHEET 4
C13	ROSE CREEK TRAIL PLAN & PROFILE SHEET 5
C14	ROSE CREEK TRAIL PLAN & PROFILE SHEET 6
C15	ROSE CREEK TRAIL PLAN & PROFILE SHEET 7
C16	ROSE CREEK TRAIL PLAN & PROFILE SHEET 8
01	OWNERSHIP MAP SHEET 1
02	OWNERSHIP MAP SHEET 2
03	OWNERSHIP MAP SHEET 3



10825 Financial Center Parkway, Suite 300  
Little Rock, Arkansas 72211  
**Crafton Tull**  
engineering | surveying  
501.664.3245 | 501.664.6704 f  
www.craftontull.com

CERTIFICATE OF AUTHORIZATION  
JOB: 23805200



ITEM	DESCRIPTION	QTY	UNIT
2.01	SITE PREPARATION	1	L.S.
3.01	UNCLASSIFIED EXCAVATION	1500	C.Y.
3.02	SELECT FILL	2000	C.Y.
4.01	AGGREGATE BASE COURSE CLASS 7	1840	TON
5.01	TACK COAT	245	GAL
6.01	ACHM SURFACE COURSE	560	TON
606.18C	FLARED END SECTION, 18"	16	EA
11.06	REINFORCED CONCRETE HEADWALL	0.75	CY
11.20	REINFORCED CONCRETE RETAINING WALL	75	CY
13.18C	STORM DRAIN PIPE, 18" CROSS DRAIN	160	L.F.
13.24C	STORM DRAIN PIPE, 24" CROSS DRAIN	20	L.F.
24.02	CHECK DAM	32	CY
18.50	ACCESS RAMP (TYPE 3)	16	S.Y.
18.55	WATER FOR DUST CONTROL	5	MGAL
19.01	FINAL CLEAN UP	1	L.S.
24.01	CONSTRUCTION ENTRANCE (CO)	3	EA
24.11	SILT FENCE - TYPE A (SFA)	3500	L.F.
24.2	PERMENANT SEEDING	1	AC.
25.01	CHAIN-LINK FENCE AND GATES	255	L.F.
719.04Y	THERMOPLASTIC PAVEMENT STRIPING YELLOW (4")	950	L.F.
719.04W	THERMOPLASTIC PAVEMENT STRIPING WHITE (4")	760	L.F.
SP	BRIDGE	240	S.F.

EXISTING

- IRON ROD ○ IR
- PK NAIL ○ PK
- R.R. SPIKE ○ RR(Sp)
- CONC. MONUMENT □ CM
- WATER VALVE X WV
- WATER METER □ WM
- FIRE HYDRANT ∇ FH
- GAS METER □ GM
- GAS VALVE ⊗ GV
- CLEAN-OUT ○ CO
- GUARD POST (BOLLARD) ● GP
- SIGN POST
- BENCHMARK
- STORM SEWER MANHOLE (D)
- SANITARY SEWER MANHOLE (S)
- TELEPHONE MANHOLE (T)
- ELECTRIC MANHOLE (E)
- TELEPHONE BOX
- ELECTRIC BOX
- CABLE BOX
- UTILITY POLE
- GUY WIRE
- LIGHT POLE
- POST OR POLE (TYPE AS NOTED)
- MAILBOX
- DECIDUOUS TREE
- EVERGREEN/CONIFEROUS TREE
- BUSH
- PROPERTY LINE
- SETBACK LINE
- EASEMENT LINE
- CURB
- FENCE
- OVERHEAD ELECTRIC
- OVERHEAD TELEPHONE
- OVERHEAD CABLE
- UNDERGROUND TELEPHONE
- UNDERGROUND ELECTRIC
- UNDERGROUND CABLE
- WATER LINE
- SEWER LINE
- GAS LINE
- STORM SEWER/CULVERT
- EDGE OF WOODS
- CONTOUR LINE

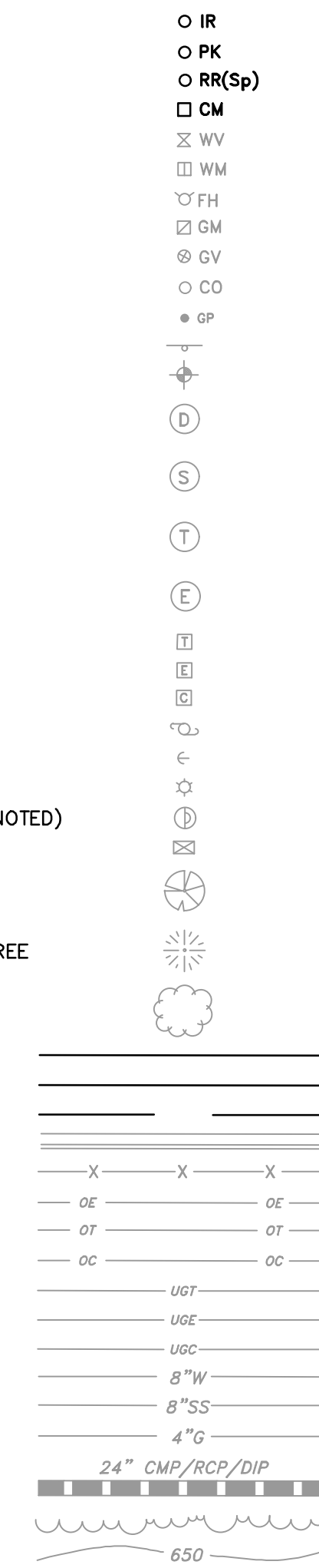

PROPOSED

- PROPOSED CONTOUR
- PROPOSED SPOT ELEVATION
- PROPOSED SPOT CURB ELEVATION
- STORM SEWER - PIPE
- STORM SEWER - MITERED END SECTION
- STORM SEWER - GRATE INLET
- STORM SEWER - JUNCTION BOX
- STORM SEWER - FLARED END SECTION
- STORM SEWER - HEADWALL
- STORM SEWER - SINGLE WING
- STORM SEWER - DOUBLE WING
- STORM SEWER - AREA INLET
- GRADE BREAK LINE
- HIGH POINT
- LOW POINT
- CUT LINE
- FILL LINE
- SANITARY SEWER PIPE
- SANITARY SEWER MANHOLE
- PROPOSED CURB
- PROPOSED CONCRETE
- CONSTRUCTION - ENTRANCE/EXIT
- CHECK DAM
- DIVERSION BERM
- DOWNDRAIN STRUCTURE - TEMPORARY
- ROCK DAM
- SEDIMENT BARRIER - SILT FENCE
- SEDIMENT BARRIER - GRAVEL RING
- SEDIMENT BARRIER - BLOCK & GRAVEL
- SEDIMENT BARRIER - BLOCK
- TEMPORARY SEDIMENT BASIN
- SILT FENCE - TYPE A
- SILT FENCE - TYPE B
- SILT FENCE - TYPE C
- STORM DRAIN OUTLET PROTECTION
- SURFACE ROUGHENING
- DISTURBED AREA STABILIZATION - TEMPORARY STABILIZATION
- DISTURBED AREA STABILIZATION - TEMPORARY GRASSING
- DISTURBED AREA STABILIZATION - PERMANENT GRASSING
- MATTING/BLANKETS

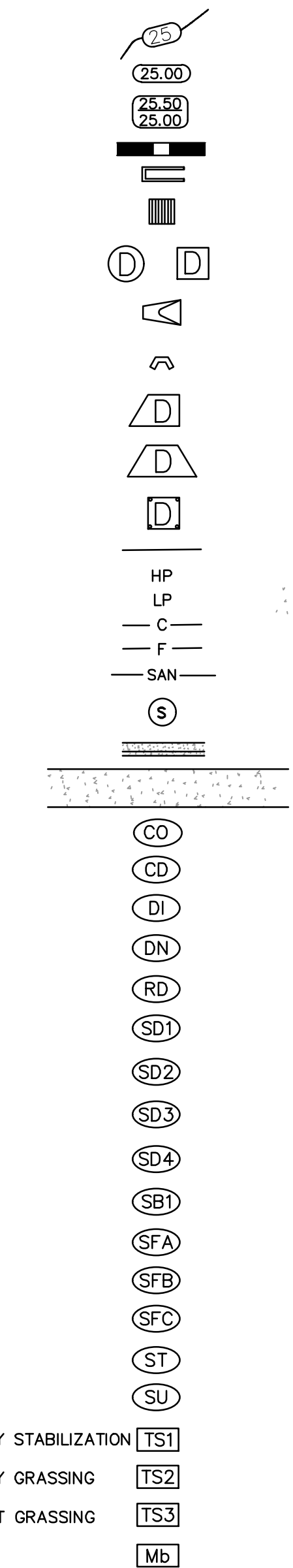

CITY OF LITTLE ROCK, ARKANSAS  
ROSE CREEK TRAIL  
LEGEND & QUANTITIES SHEET

DEPARTMENT OF PUBLIC WORKS  
CIVIL ENGINEERING  
701 W. MARKHAM  
LITTLE ROCK, ARKANSAS 72201



DRAWN BY  
AS  
DESIGNED  
AT  
CHECKED  
BAP  
DATE  
02-19-2024  
SCALE

PROJECT NO.

SHEET NO.  
C2



DRAWN BY  
AS  
DESIGNED  
AT  
CHECKED  
BAP  
DATE  
02-19-2024  
SCALE  
NO SCALE  
PROJECT NO.

SHEET NO.  
**C3**

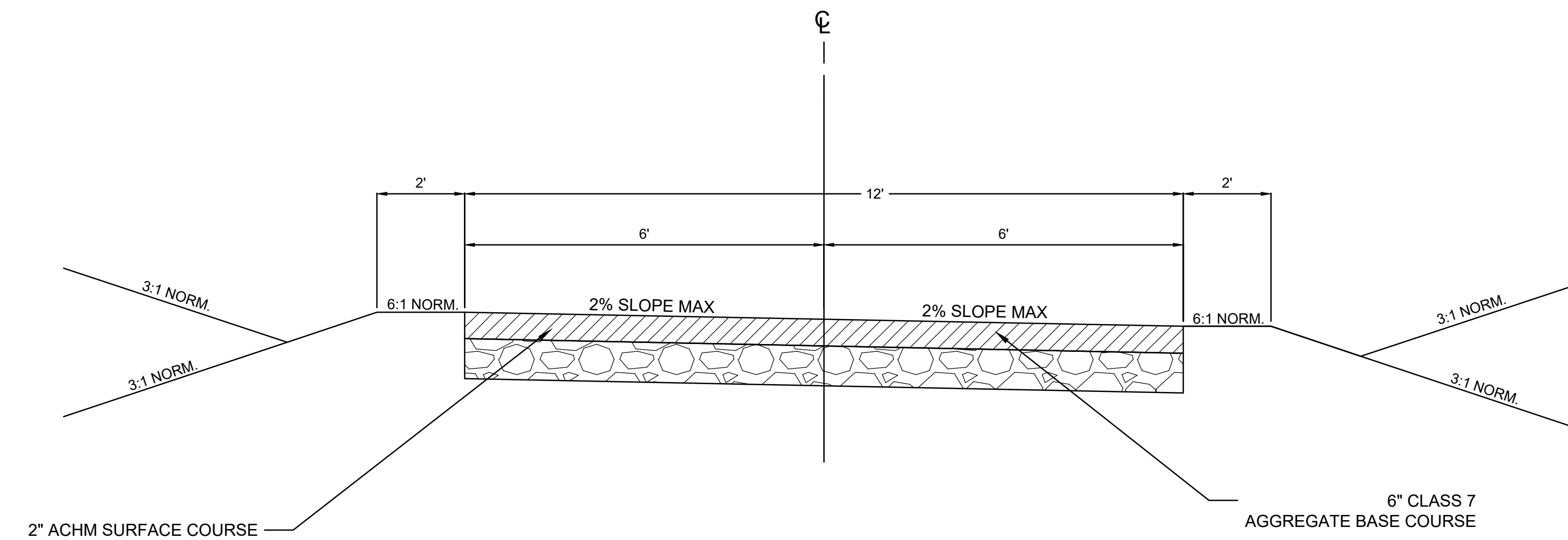

**TYPICAL TRAIL SECTION**

N.T.S  
STA. 20+00.00 - 28+75.00  
STA. 30+00.00 - 49+33.36

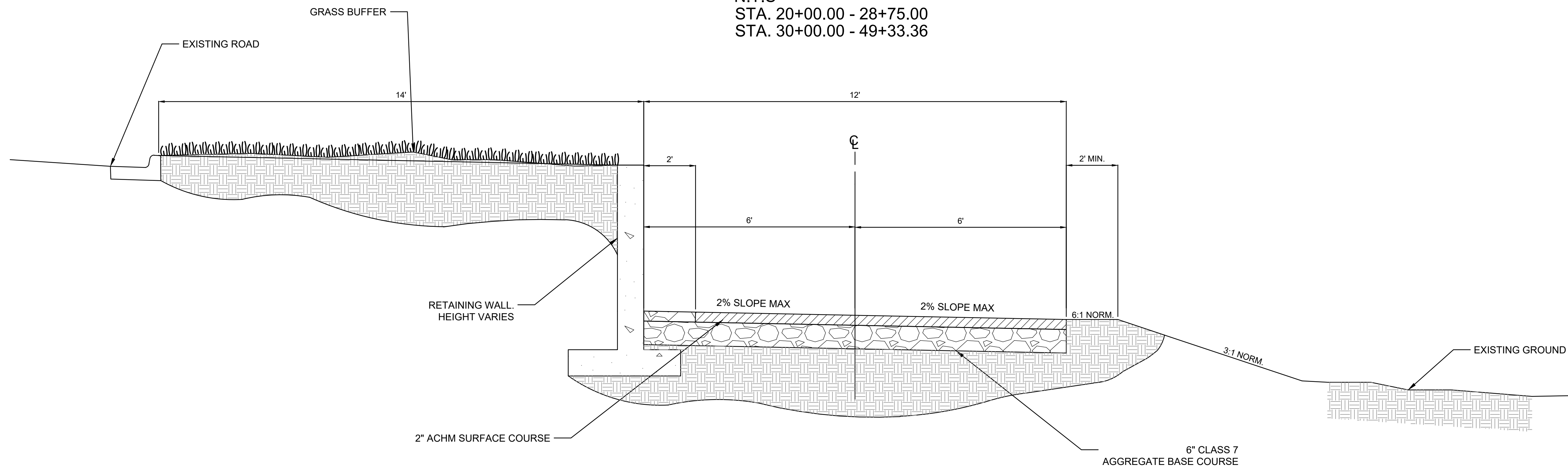

**TRAIL SECTION W/ RETAINING WALL**

N.T.S  
STA. 10+00.00 - 13+01.96

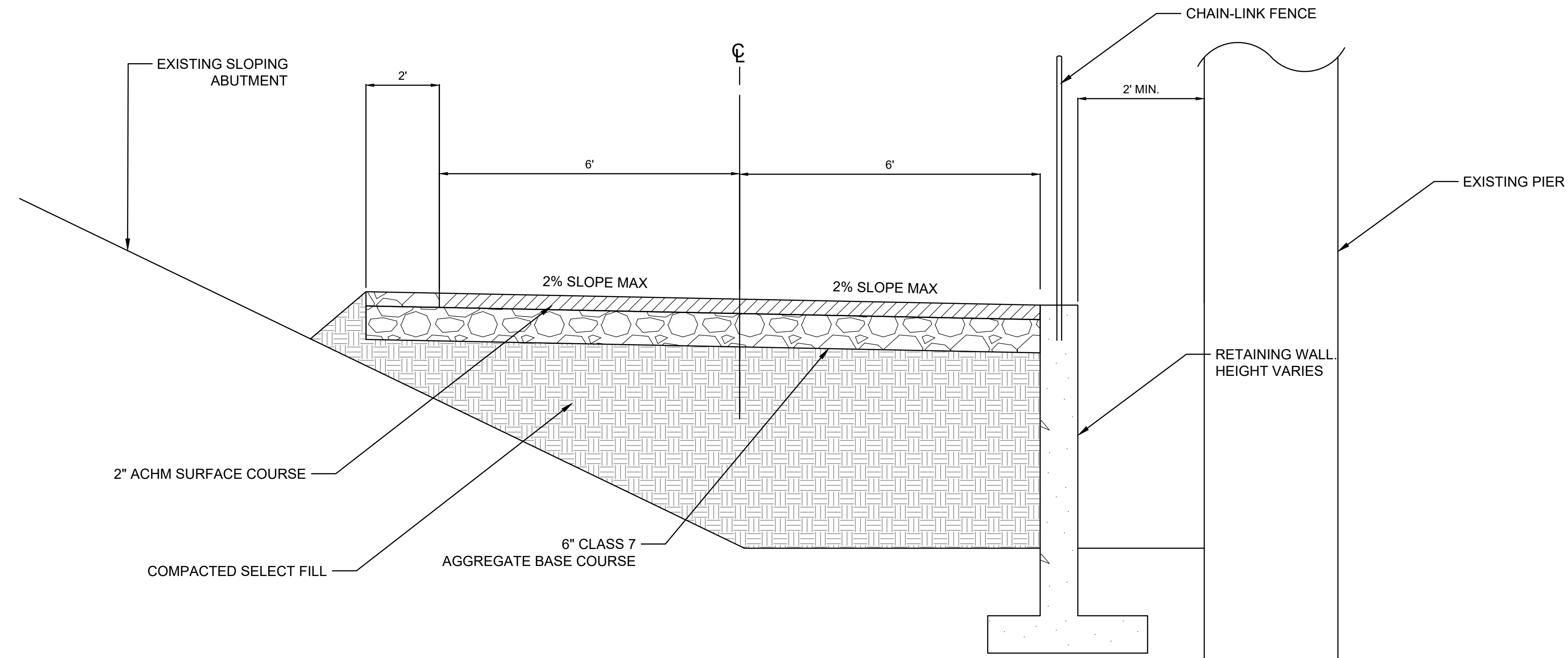

### RETAINING WALL W/ FILL SECTION

N.T.S  
STA. 28+75.00 - 30+00.00

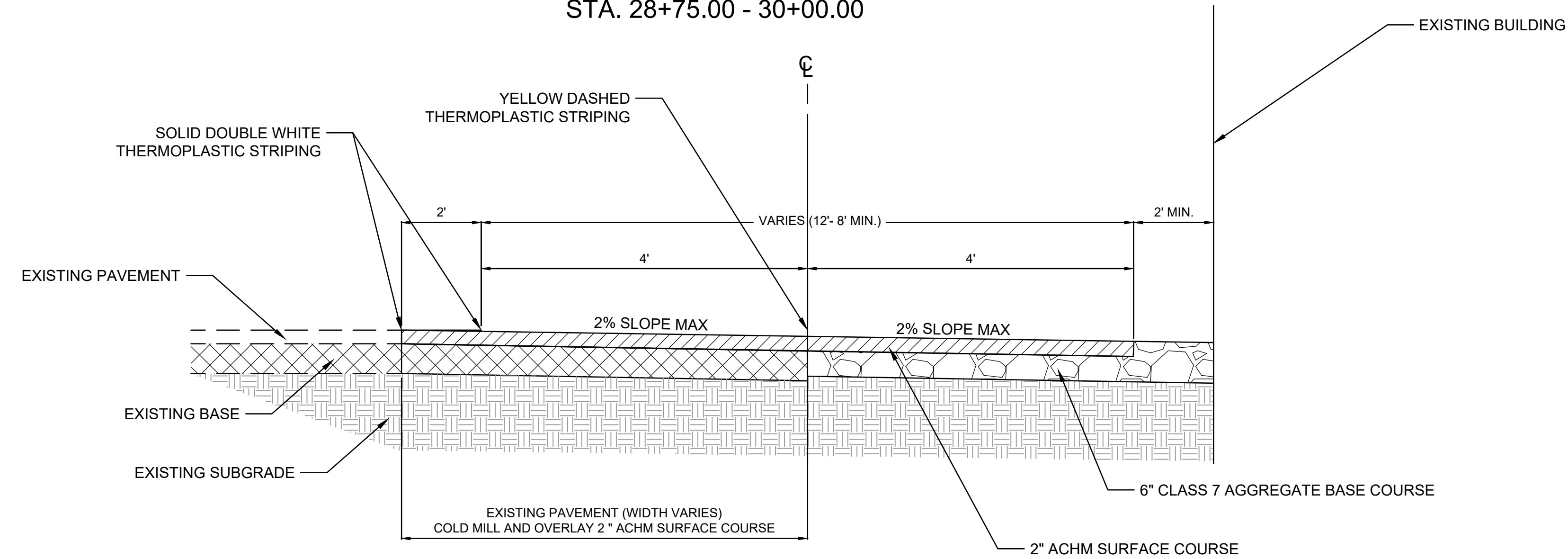

### CYCLE TRACK SECTION

N.T.S  
STA. 49+33.36 - 54+76.83

CITY OF LITTLE ROCK, ARKANSAS  
ROSE CREEK TRAIL  
TYPICAL SECTIONS SHEET 2

DEPARTMENT OF PUBLIC WORKS  
CIVIL ENGINEERING  
701 W. MARKHAM  
LITTLE ROCK, ARKANSAS 72201

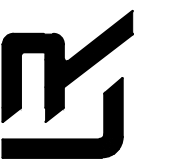

DRAWN BY  
AS  
DESIGNED  
AT  
CHECKED  
BAP  
DATE  
02-19-2024  
SCALE  
NO SCALE  
PROJECT NO.

SHEET NO.  
C4



CITY OF LITTLE ROCK, ARKANSAS  
 ROSE CREEK TRAIL  
 OVERALL SITE SHEET

DEPARTMENT OF PUBLIC WORKS  
 CIVIL ENGINEERING  
 701 W. MARKHAM  
 LITTLE ROCK, ARKANSAS 72201

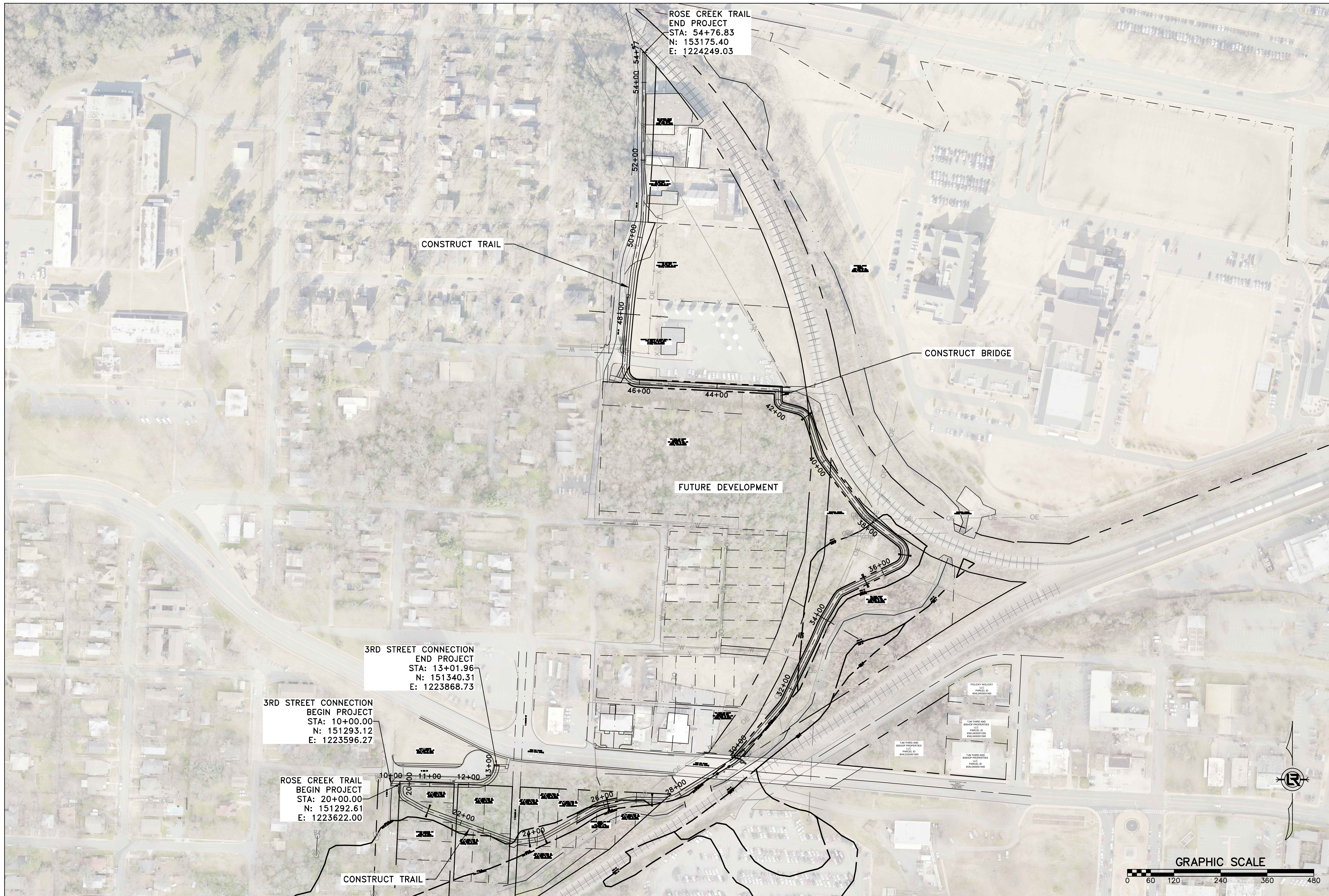

DRAWN BY  
 AS  
 DESIGNED  
 AT  
 CHECKED  
 BAP  
 DATE  
 02-19-2024  
 SCALE  
 1"=120'  
 PROJECT NO.

SHEET NO.  
 C5





REVISIONS	DATE

CITY OF LITTLE ROCK, ARKANSAS  
 ROSE CREEK TRAIL  
 SITE ENLARGEMENT SHEET 2

DEPARTMENT OF PUBLIC WORKS  
 CIVIL ENGINEERING  
 701 W. MARKHAM  
 LITTLE ROCK, ARKANSAS 72201

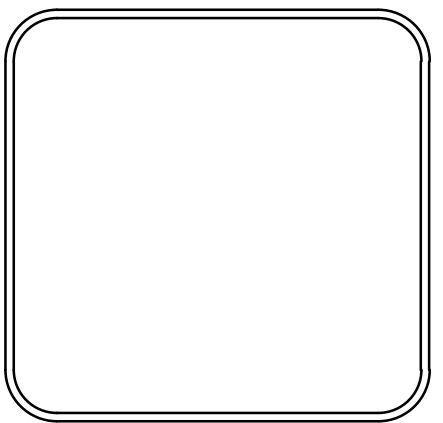

DRAWN BY  
 AS  
 DESIGNED  
 AT  
 CHECKED  
 BAP  
 DATE  
 02-19-2024  
 SCALE  
 1"=50'  
 PROJECT NO.

SHEET NO.  
 C7



REVISIONS	DATE

CITY OF LITTLE ROCK, ARKANSAS  
 ROSE CREEK TRAIL  
 SITE ENLARGEMENT SHEET 3

DEPARTMENT OF PUBLIC WORKS  
 CIVIL ENGINEERING  
 701 W. MARKHAM  
 LITTLE ROCK, ARKANSAS 72201

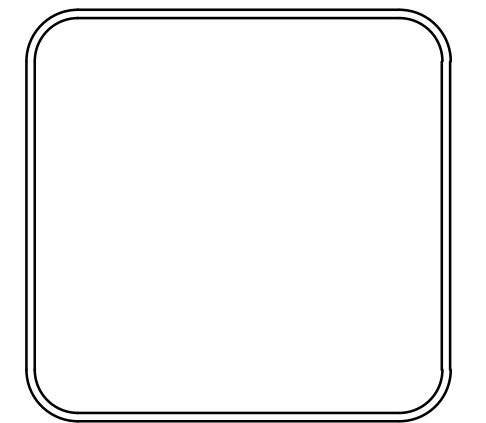

DRAWN BY  
 AS  
 DESIGNED  
 AT  
 CHECKED  
 BAP  
 DATE  
 02-19-2024  
 SCALE  
 1"=50'  
 PROJECT NO.  
 SHEET NO.  
 C8

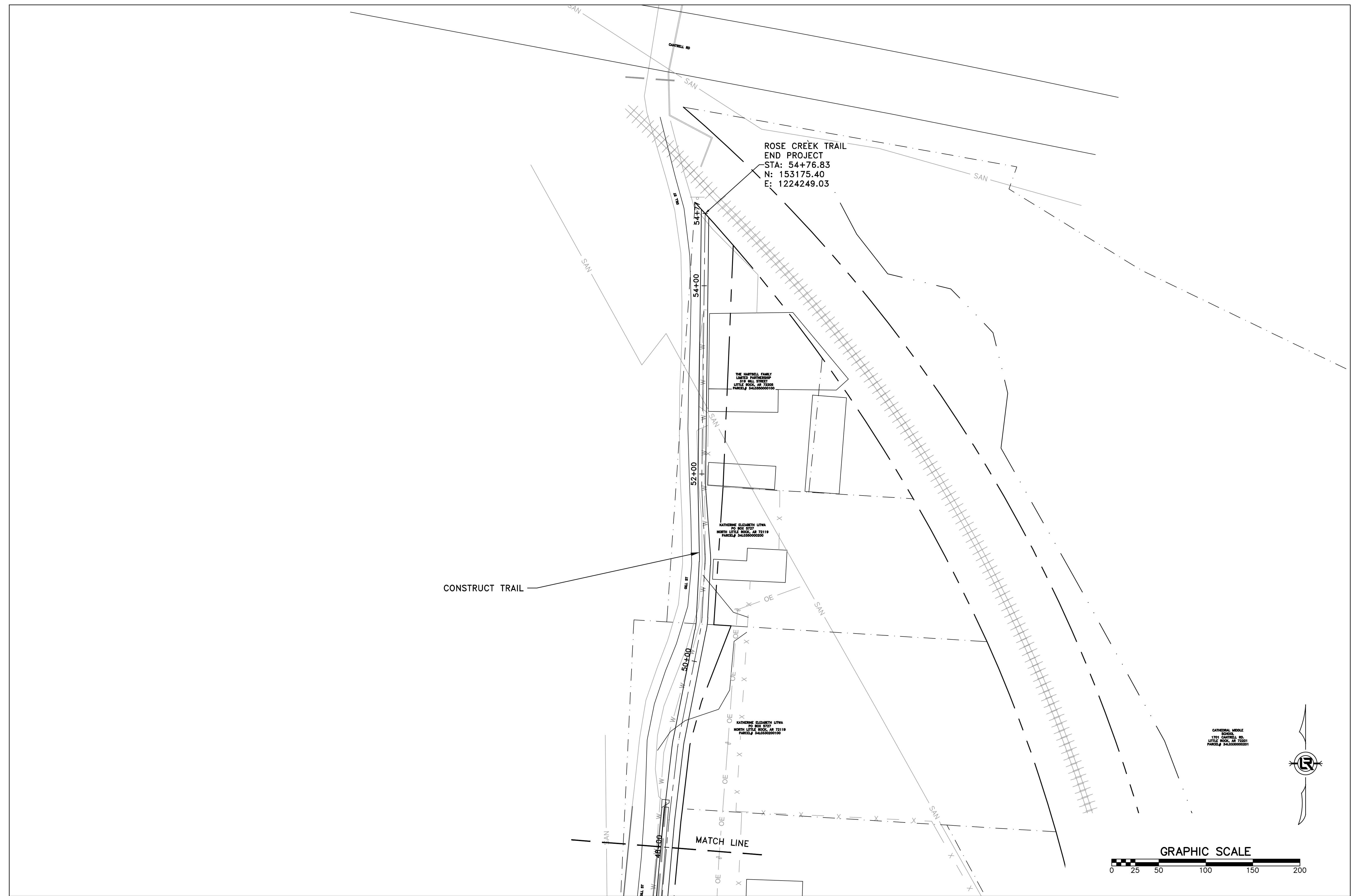





CITY OF LITTLE ROCK, ARKANSAS  
ROSE CREEK TRAIL  
ROSE CREEK TRAIL PLAN & PROFILE SHEET 1

DEPARTMENT OF PUBLIC WORKS  
CIVIL ENGINEERING  
701 W. MARKHAM  
LITTLE ROCK, ARKANSAS 72201

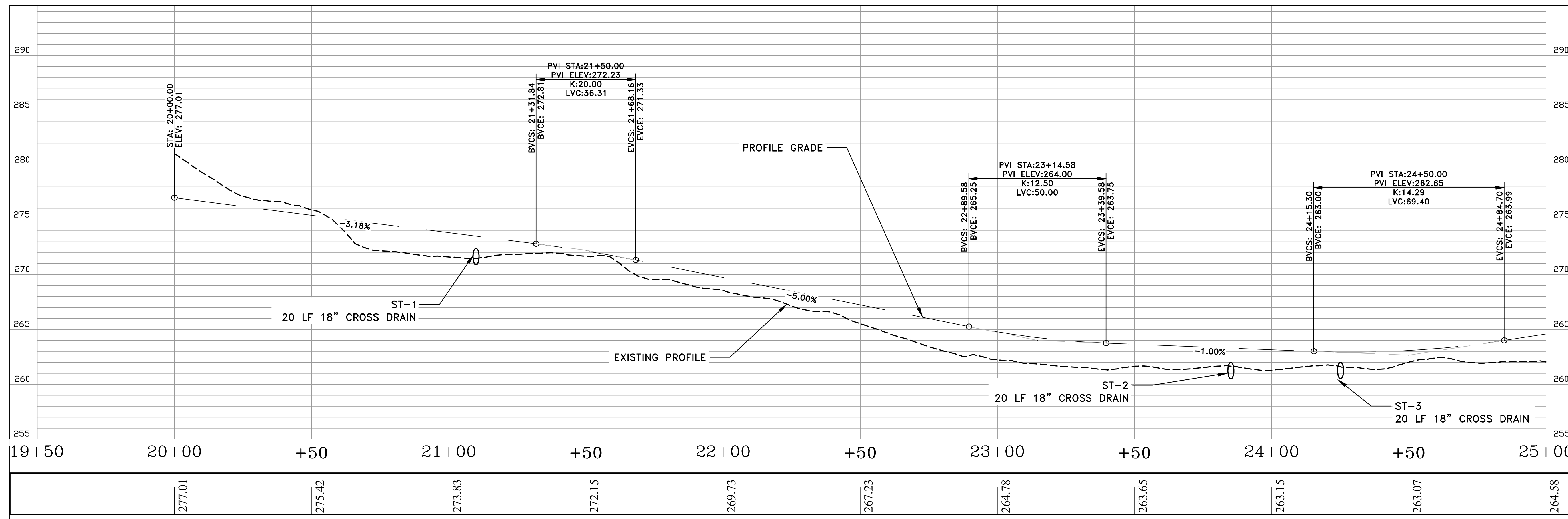
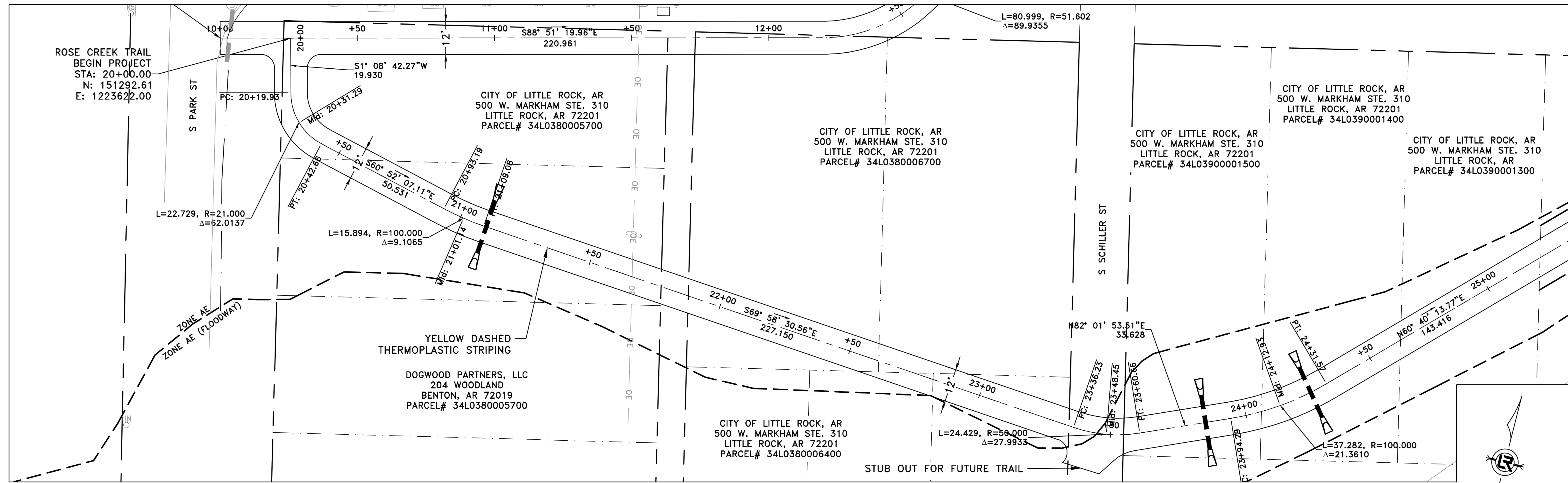

DRAWN BY  
AS  
DESIGNED  
AT  
CHECKED  
BAP  
DATE  
02-19-2024  
SCALE  
H: 1"=20'  
V: 1"=5'  
PROJECT NO.

SHEET NO.  
C9



REVISIONS	DATE

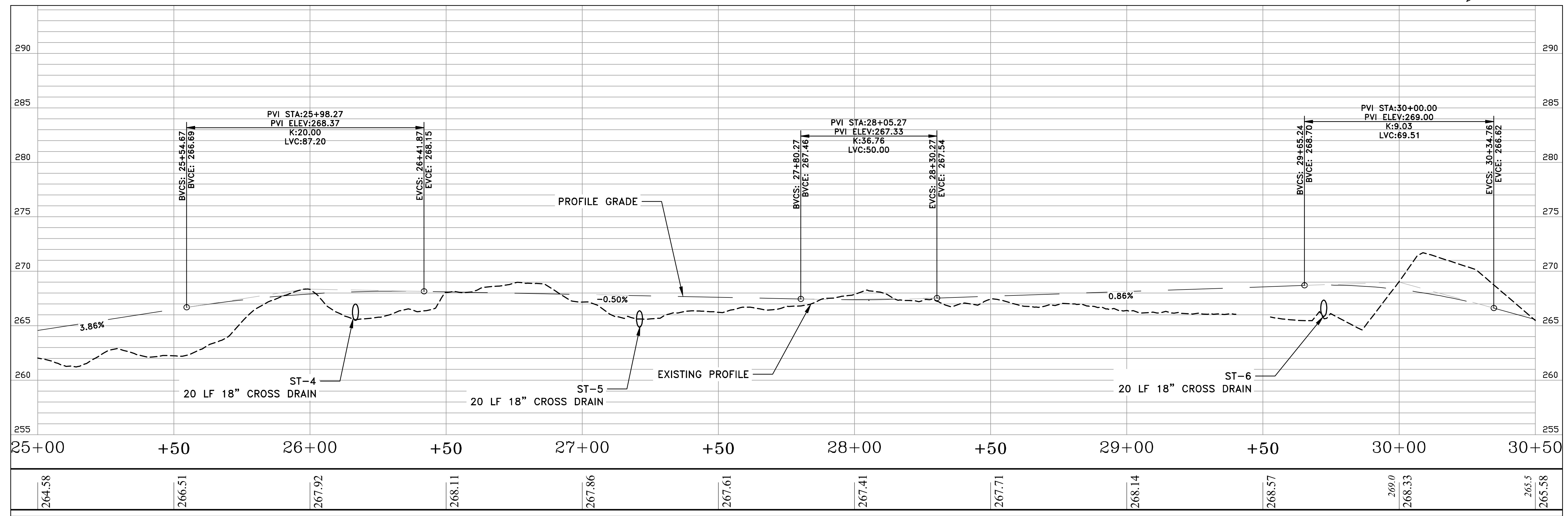
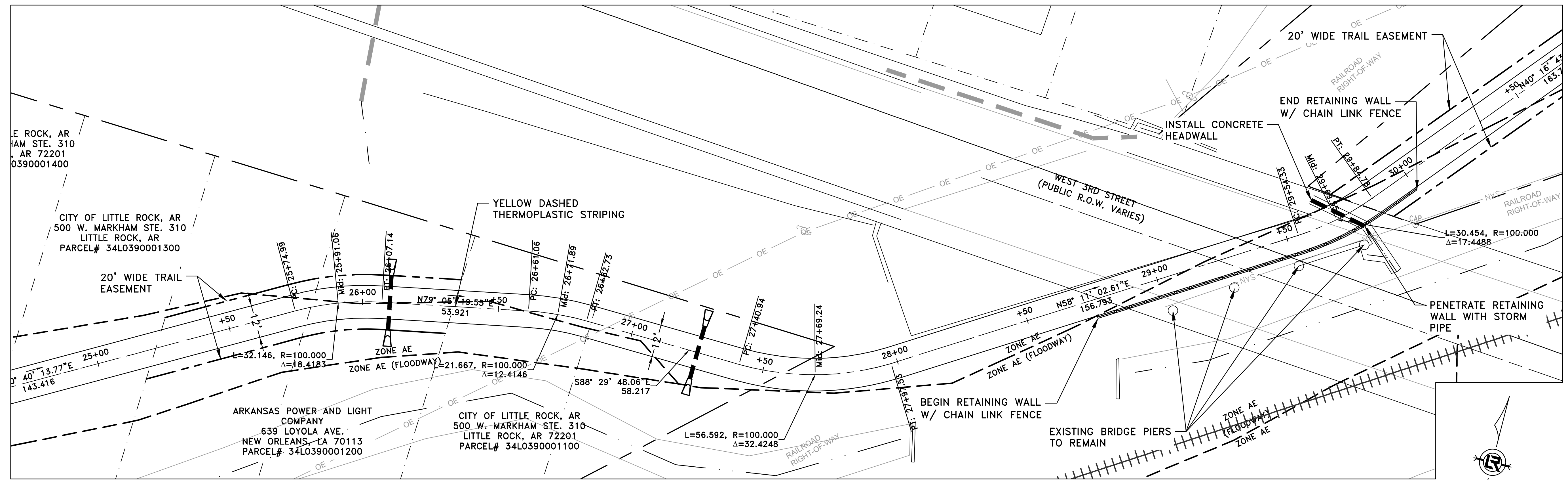

CITY OF LITTLE ROCK, ARKANSAS  
ROSE CREEK TRAIL  
ROSE CREEK TRAIL PLAN & PROFILE SHEET 2

DEPARTMENT OF PUBLIC WORKS  
CIVIL ENGINEERING  
701 W. MARKHAM  
LITTLE ROCK, ARKANSAS 72201

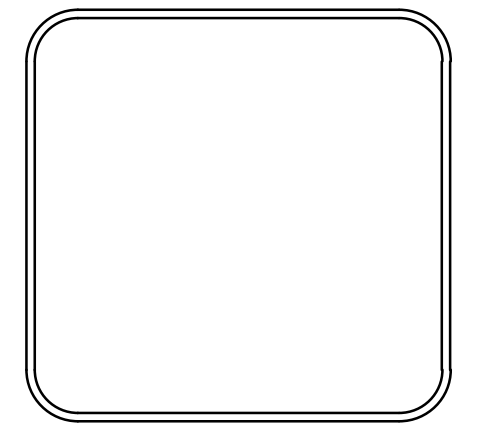

DRAWN BY  
AS  
DESIGNED  
AT  
CHECKED  
BAP  
DATE  
02-19-2024  
SCALE  
H: 1"=20'  
V: 1"=5'  
PROJECT NO.

SHEET NO.  
**C10**

REVISIONS	DATE

CITY OF LITTLE ROCK, ARKANSAS  
 ROSE CREEK TRAIL  
 ROSE CREEK TRAIL PLAN & PROFILE SHEET 3

DEPARTMENT OF PUBLIC WORKS  
 CIVIL ENGINEERING  
 701 W. MARKHAM  
 LITTLE ROCK, ARKANSAS 72201

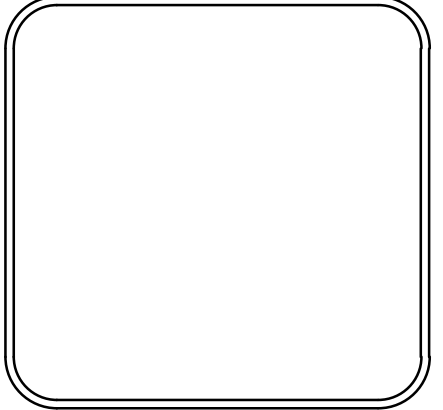

DRAWN BY  
 AS  
 DESIGNED  
 AT  
 CHECKED  
 BAP  
 DATE  
 02-19-2024  
 SCALE  
 H: 1"=20'  
 V: 1"=5'  
 PROJECT NO.

SHEET NO.  
 C11

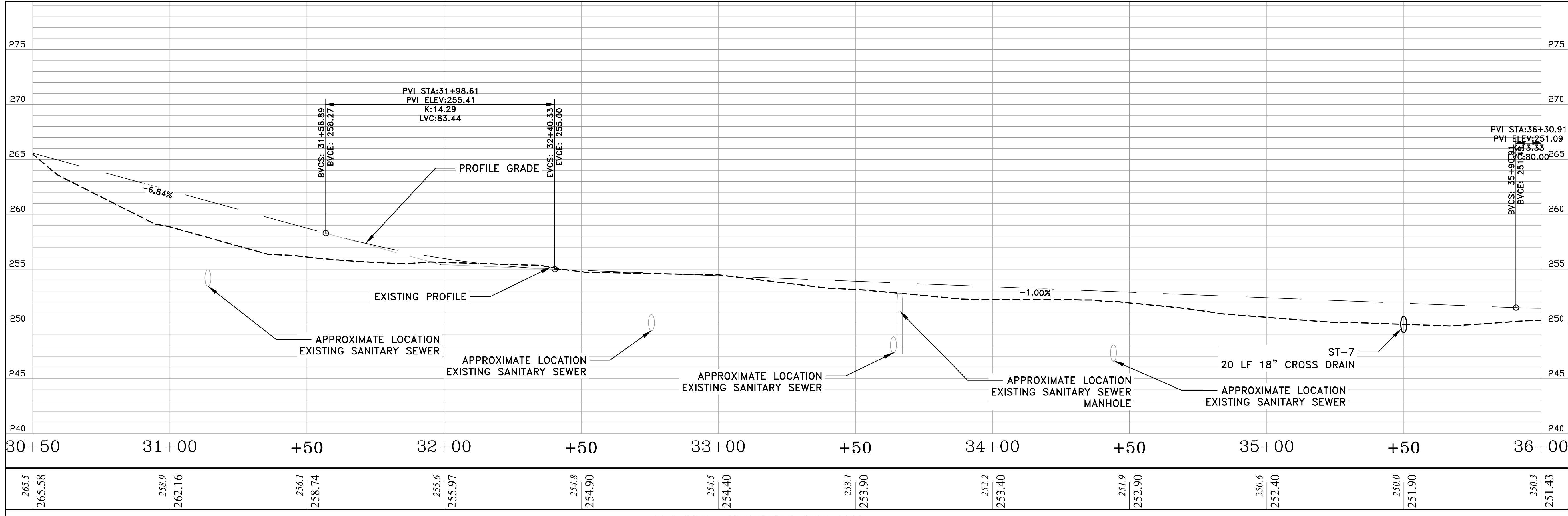
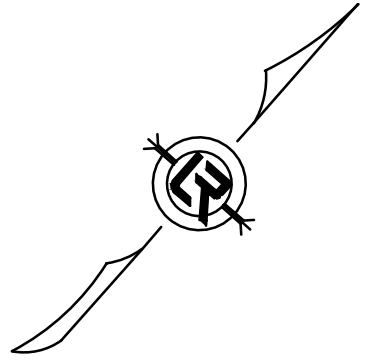
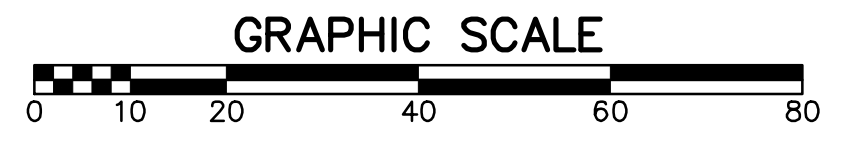
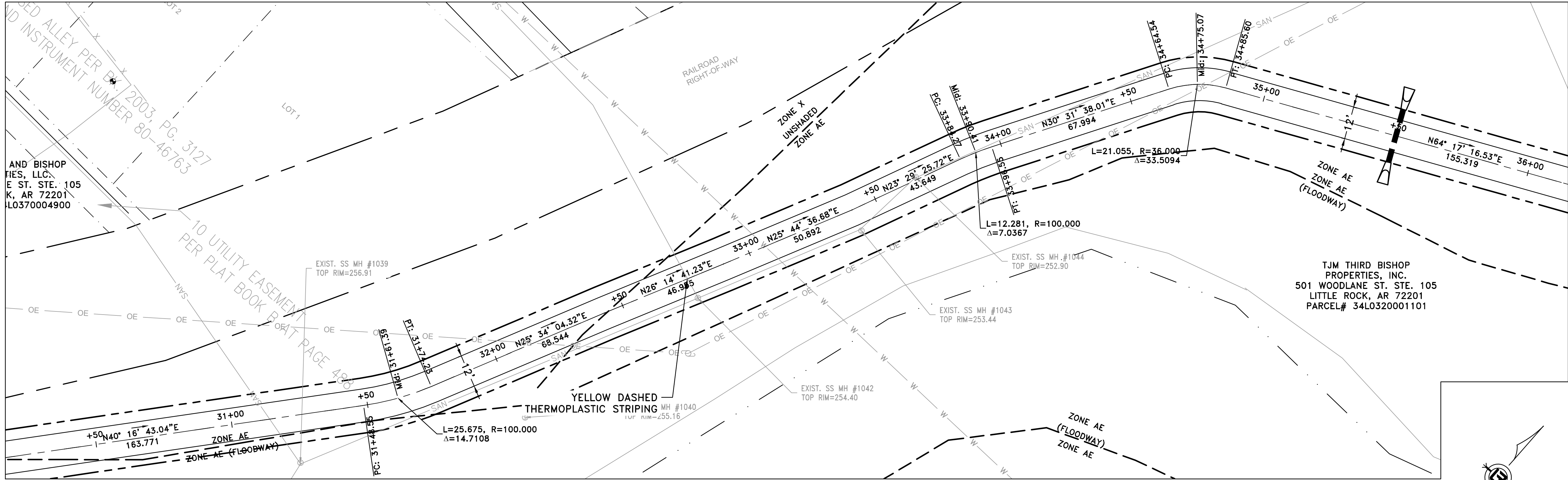

REVISIONS	DATE

CITY OF LITTLE ROCK, ARKANSAS  
ROSE CREEK TRAIL  
ROSE CREEK TRAIL PLAN & PROFILE SHEET 4

DEPARTMENT OF PUBLIC WORKS  
CIVIL ENGINEERING  
701 W. MARKHAM  
LITTLE ROCK, ARKANSAS 72201

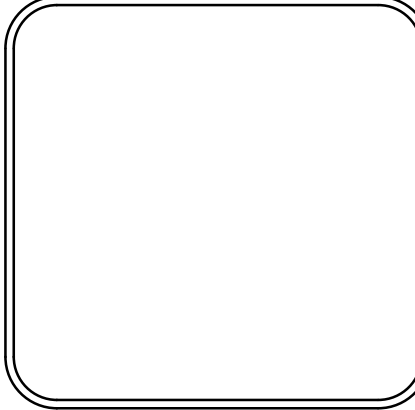

DRAWN BY  
AS  
DESIGNED  
AT  
CHECKED  
BAP  
DATE  
02-19-2024  
SCALE  
H: 1"=20'  
V: 1"=5'  
PROJECT NO.

SHEET NO.  
C12

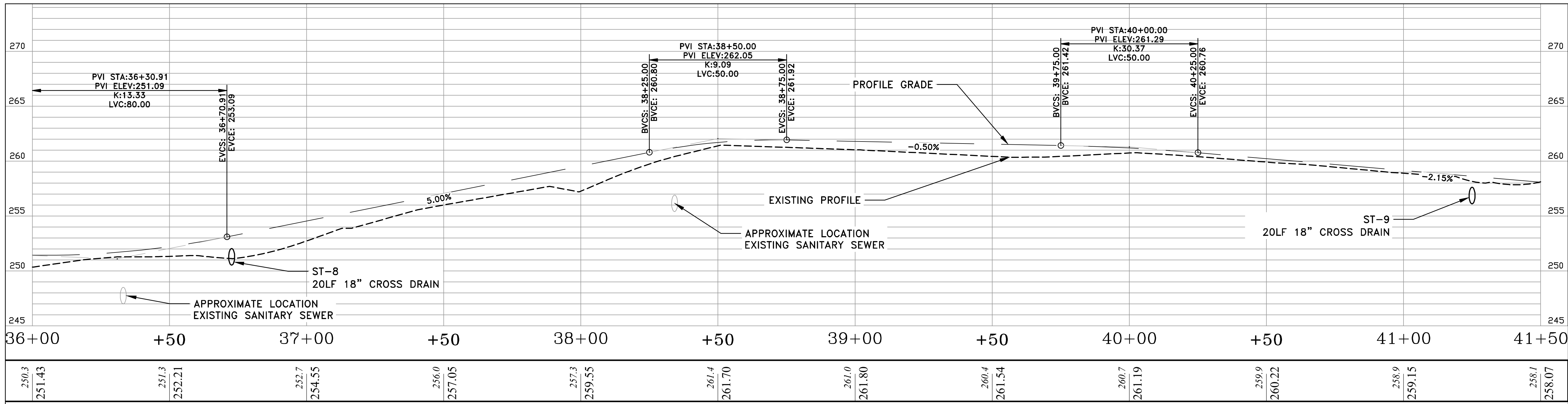
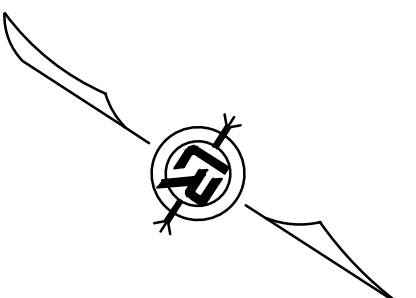
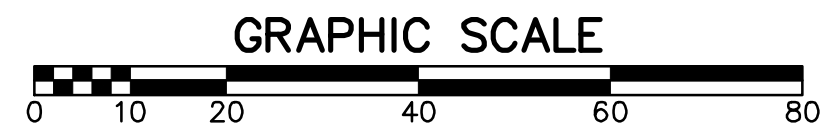
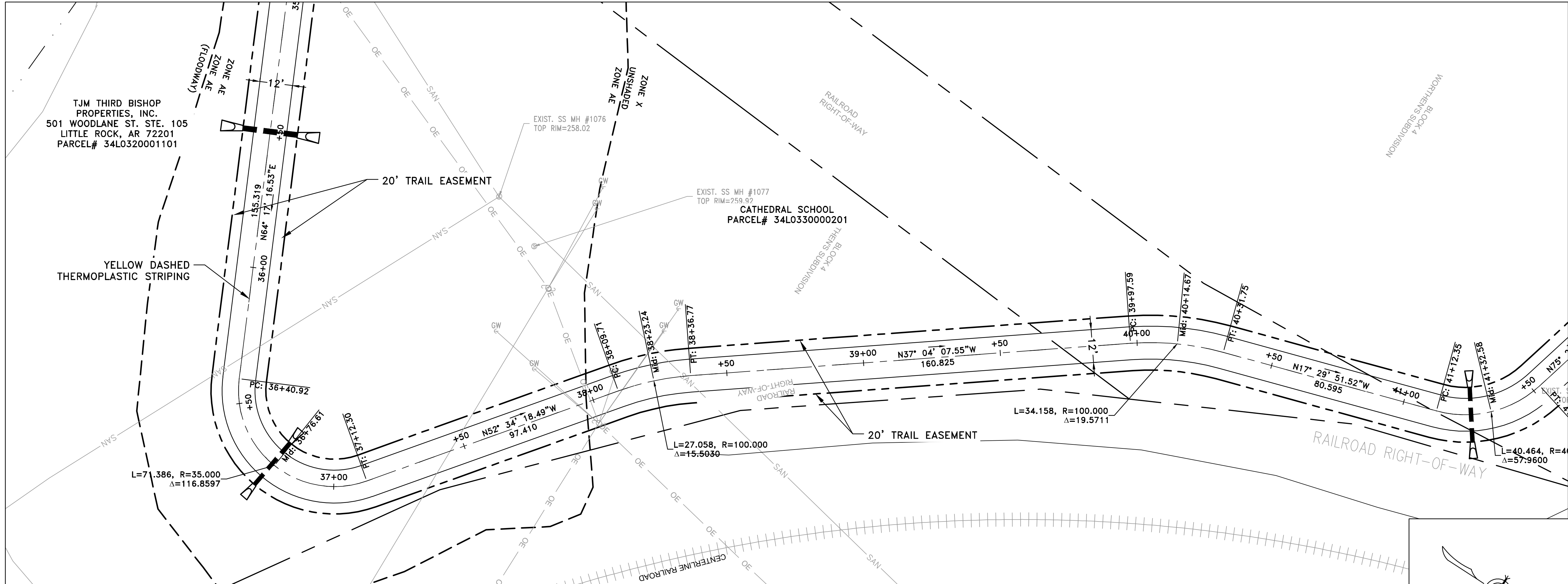

REVISIONS	DATE

CITY OF LITTLE ROCK, ARKANSAS  
 ROSE CREEK TRAIL  
 ROSE CREEK TRAIL PLAN & PROFILE SHEET 5

DEPARTMENT OF PUBLIC WORKS  
 CIVIL ENGINEERING  
 701 W. MARKHAM  
 LITTLE ROCK, ARKANSAS 72201

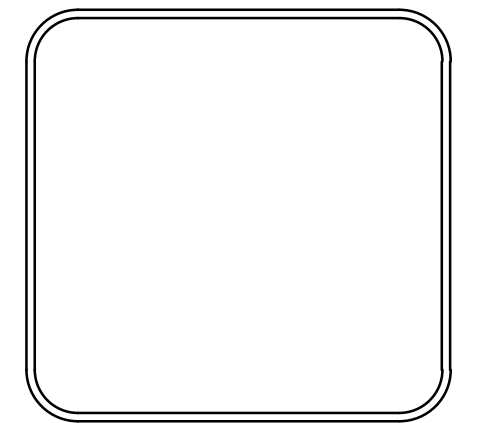

DRAWN BY  
 AS  
 DESIGNED  
 AT  
 CHECKED  
 BAP  
 DATE  
 02-19-2024  
 SCALE  
 H: 1"=20'  
 V: 1"=5'  
 PROJECT NO.

SHEET NO.  
 C13

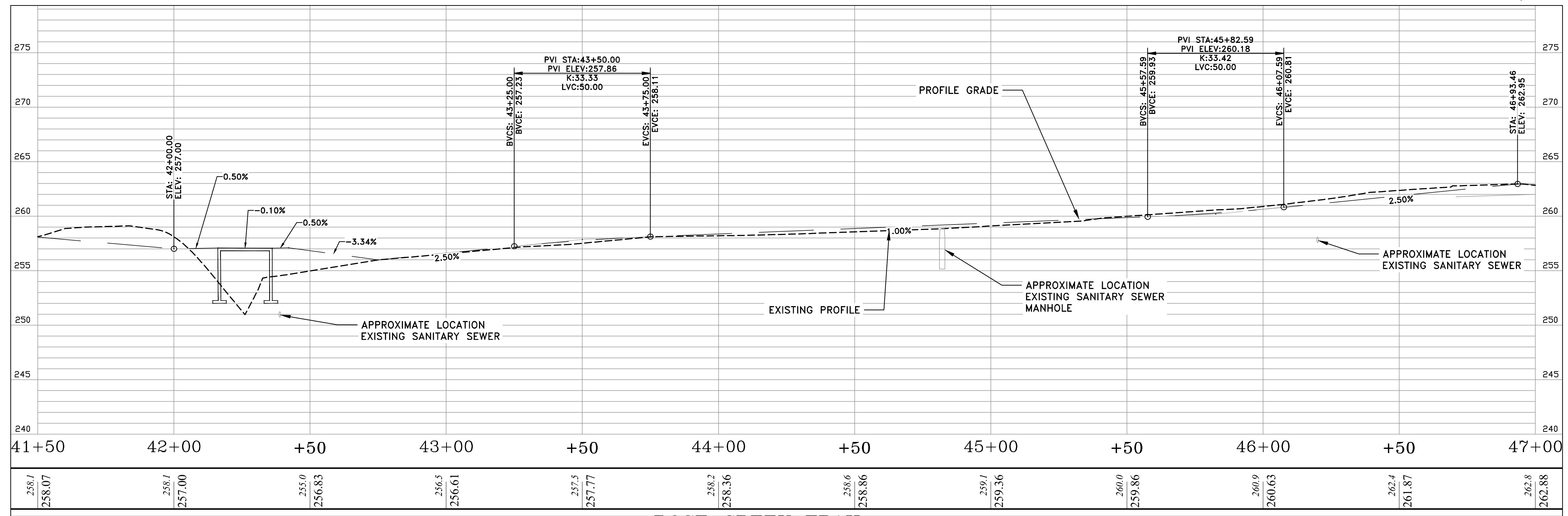
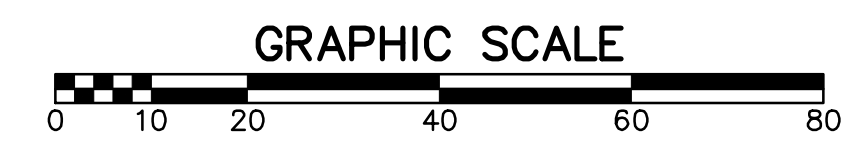
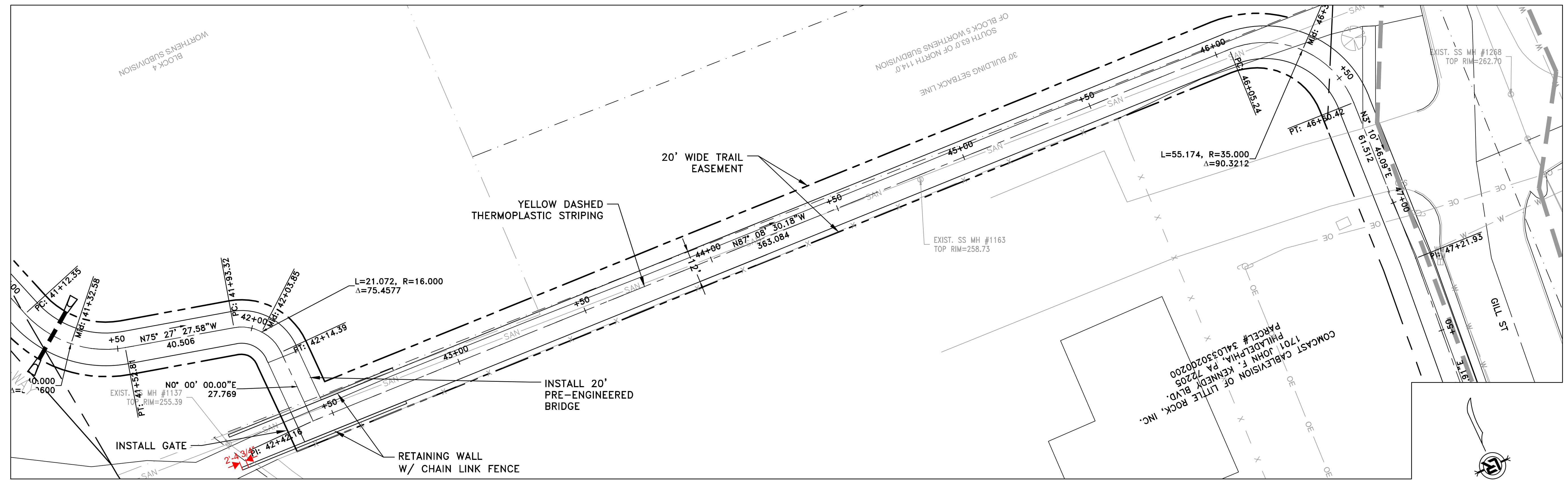

REVISIONS	DATE

CITY OF LITTLE ROCK, ARKANSAS  
ROSE CREEK TRAIL  
ROSE CREEK TRAIL PLAN & PROFILE SHEET 6

DEPARTMENT OF PUBLIC WORKS  
CIVIL ENGINEERING  
701 W. MARKHAM  
LITTLE ROCK, ARKANSAS 72201

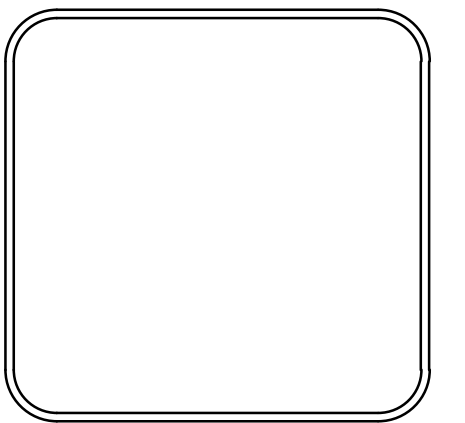
DRAWN BY  
AS  
DESIGNED  
AT  
CHECKED  
BAP  
DATE  
02-19-2024  
SCALE  
H: 1"=20'  
V: 1"=5'  
PROJECT NO.

SHEET NO.  
C14

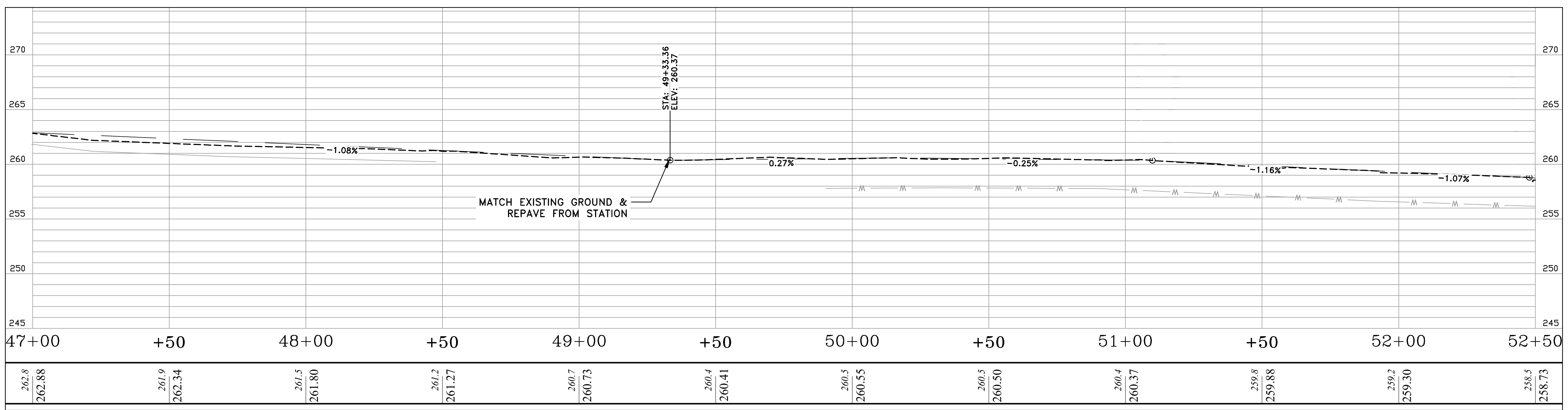
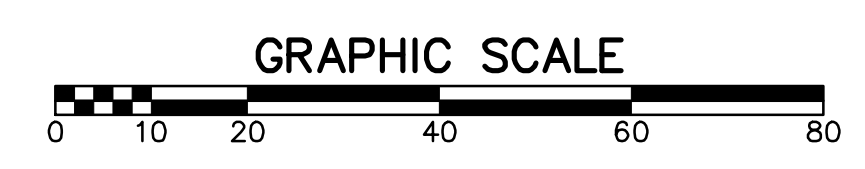
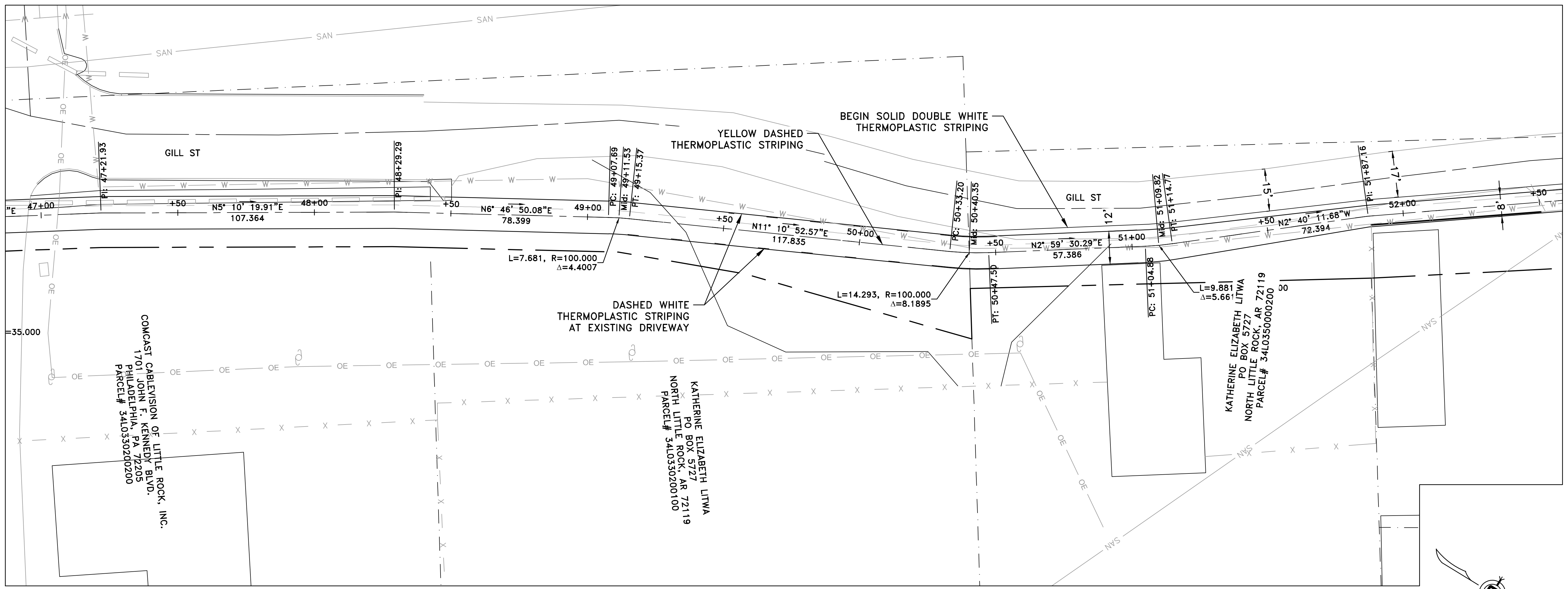

REVISIONS	DATE

CITY OF LITTLE ROCK, ARKANSAS  
 ROSE CREEK TRAIL  
 ROSE CREEK TRAIL PLAN & PROFILE SHEET 7

DEPARTMENT OF PUBLIC WORKS  
 CIVIL ENGINEERING  
 701 W. MARKHAM  
 LITTLE ROCK, ARKANSAS 72201



DRAWN BY  
 AS  
 DESIGNED  
 AT  
 CHECKED  
 BAP  
 DATE  
 02-19-2024  
 SCALE  
 H: 1"=20'  
 V: 1"=5'  
 PROJECT NO.

SHEET NO.  
 C15

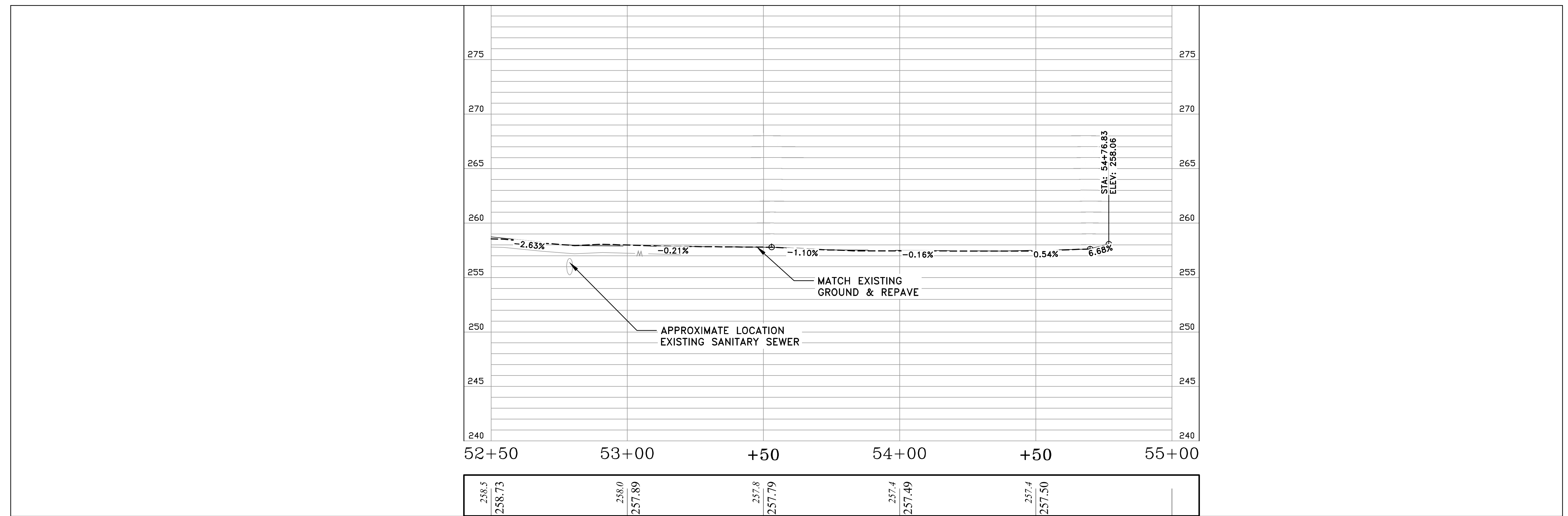
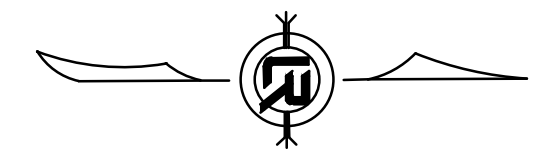
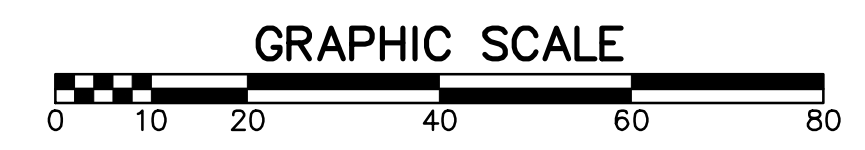
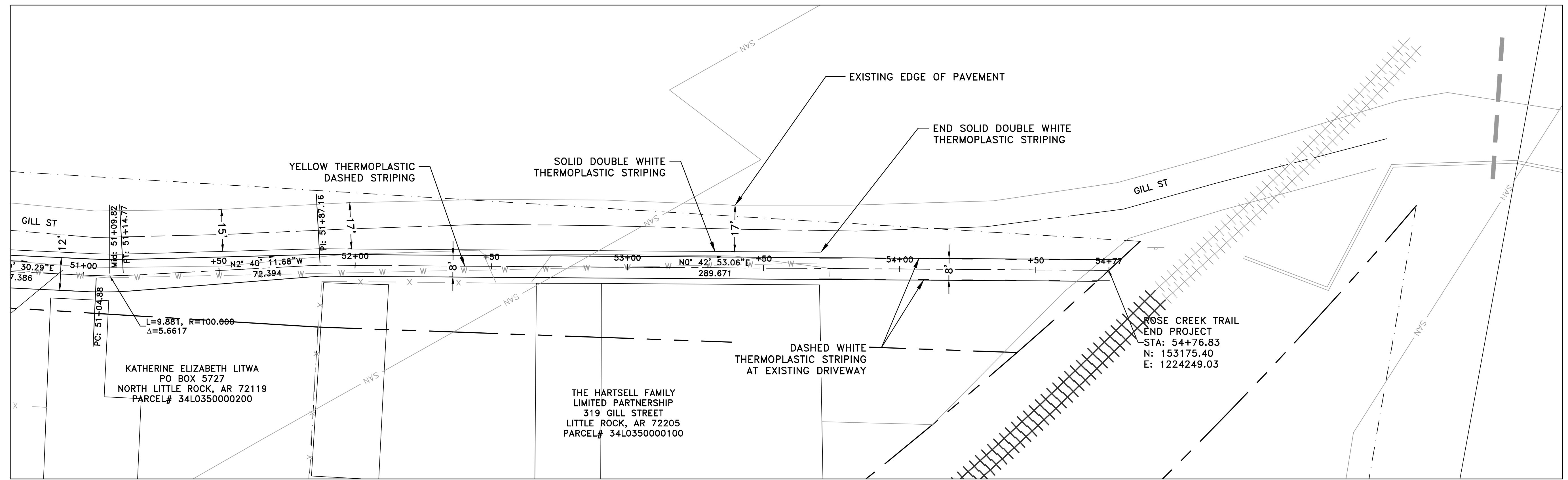

CITY OF LITTLE ROCK, ARKANSAS  
ROSE CREEK TRAIL

ROSE CREEK TRAIL PLAN & PROFILE SHEET 8

DEPARTMENT OF PUBLIC WORKS  
CIVIL ENGINEERING  
701 W. MARKHAM  
LITTLE ROCK, ARKANSAS 72201



DRAWN BY  
AS  
DESIGNED  
AT  
CHECKED  
BAP  
DATE  
02-19-2024  
SCALE  
H: 1"=20'  
V: 1"=5'  
PROJECT NO.

SHEET NO.  
C16

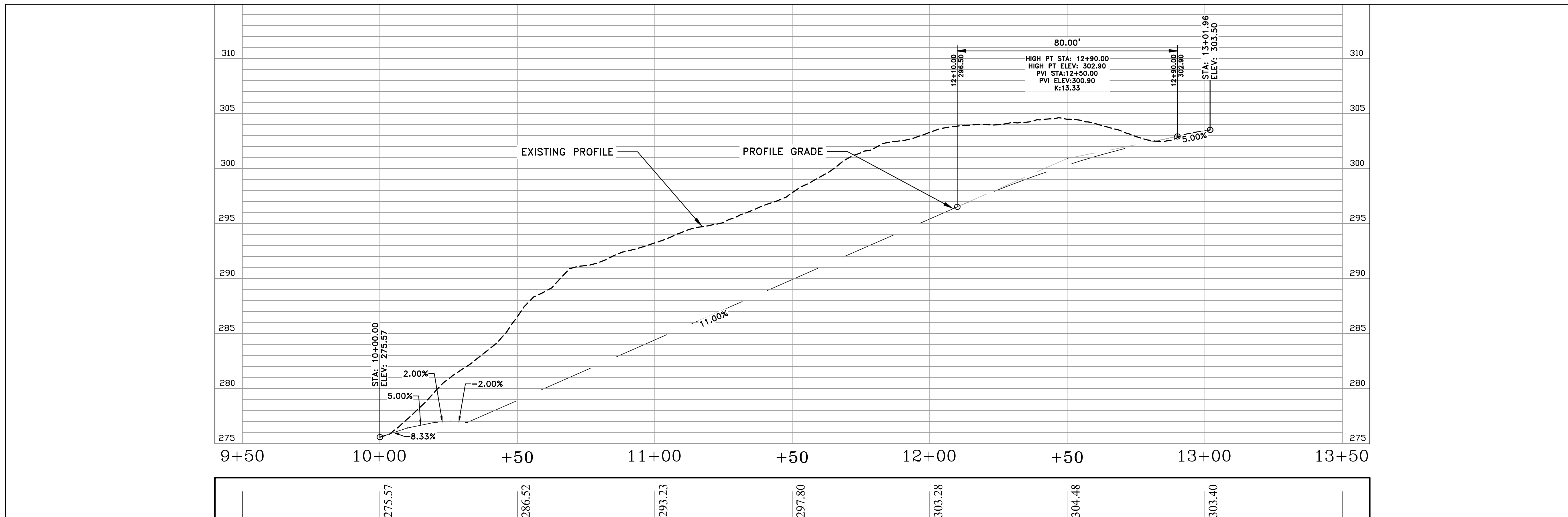
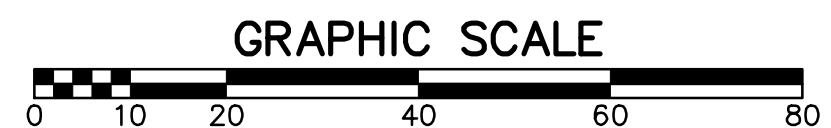
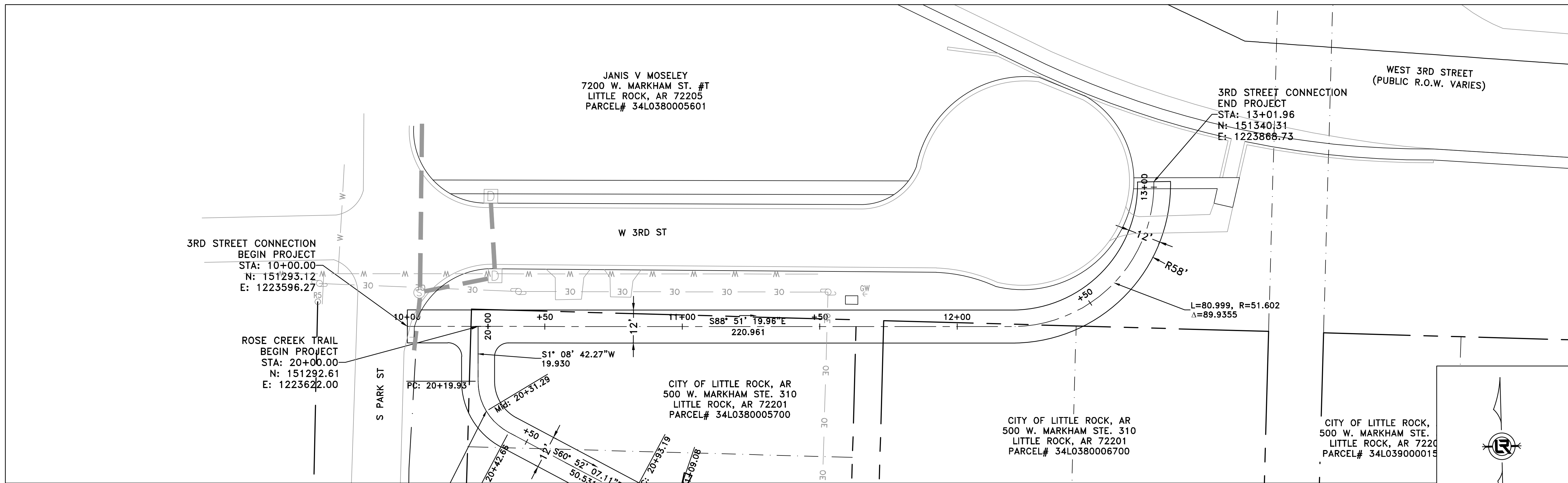



30% SUBMITTAL

REVISIONS	DATE

CITY OF LITTLE ROCK, ARKANSAS  
 ROSE CREEK TRAIL  
 OWNERSHIP MAP SHEET 1

DEPARTMENT OF PUBLIC WORKS  
 CIVIL ENGINEERING  
 701 W. MARKHAM  
 LITTLE ROCK, ARKANSAS 72201

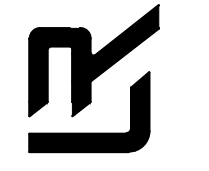
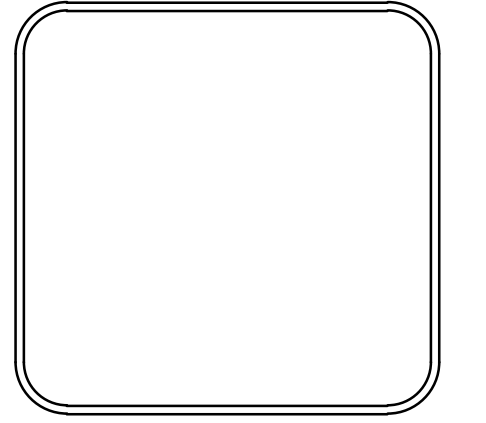
DRAWN BY  
 AS  
 DESIGNED  
 AT  
 CHECKED  
 BAP  
 DATE  
 02-19-2024  
 SCALE  
 H: 1"=20'  
 V: 1"=40'  
 PROJECT NO.  
 SHEET NO.  
 01

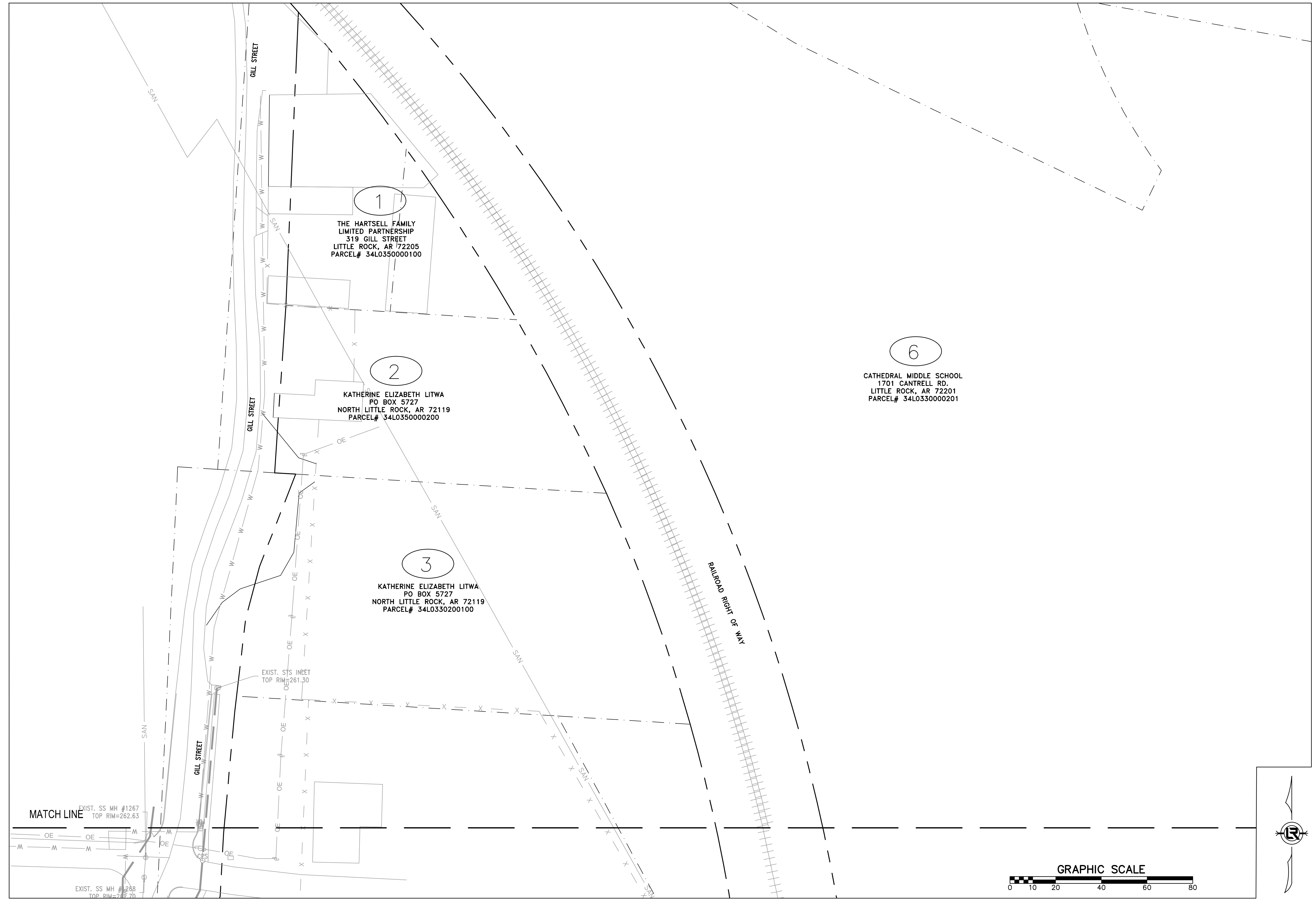

MATCH LINE  
 EXIST. SS MH #1267  
 TOP RIM=262.63

EXIST. SS MH #268  
 TOP RIM=249.71

EXIST. STS INLET  
 TOP RIM=261.30

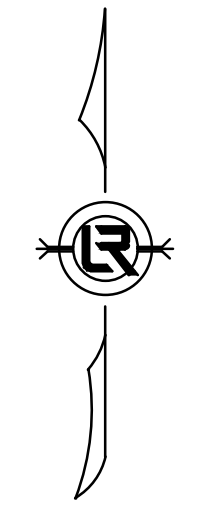
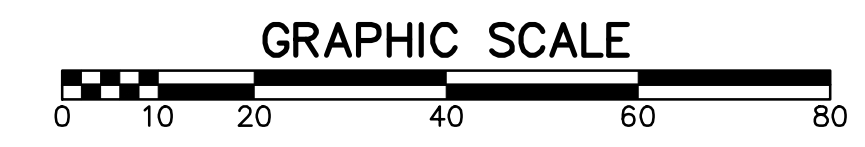

REVISIONS	DATE

CITY OF LITTLE ROCK, ARKANSAS  
 ROSE CREEK TRAIL  
 OWNERSHIP MAP SHEET 2

DEPARTMENT OF PUBLIC WORKS  
 CIVIL ENGINEERING  
 701 W. MARKHAM  
 LITTLE ROCK, ARKANSAS 72201

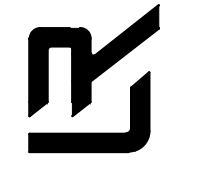

DRAWN BY  
 AS  
 DESIGNED  
 AT  
 CHECKED  
 BAP  
 DATE  
 02-19-2024  
 SCALE  
 1" = 40'  
 PROJECT NO.  
 SHEET NO.  
 02

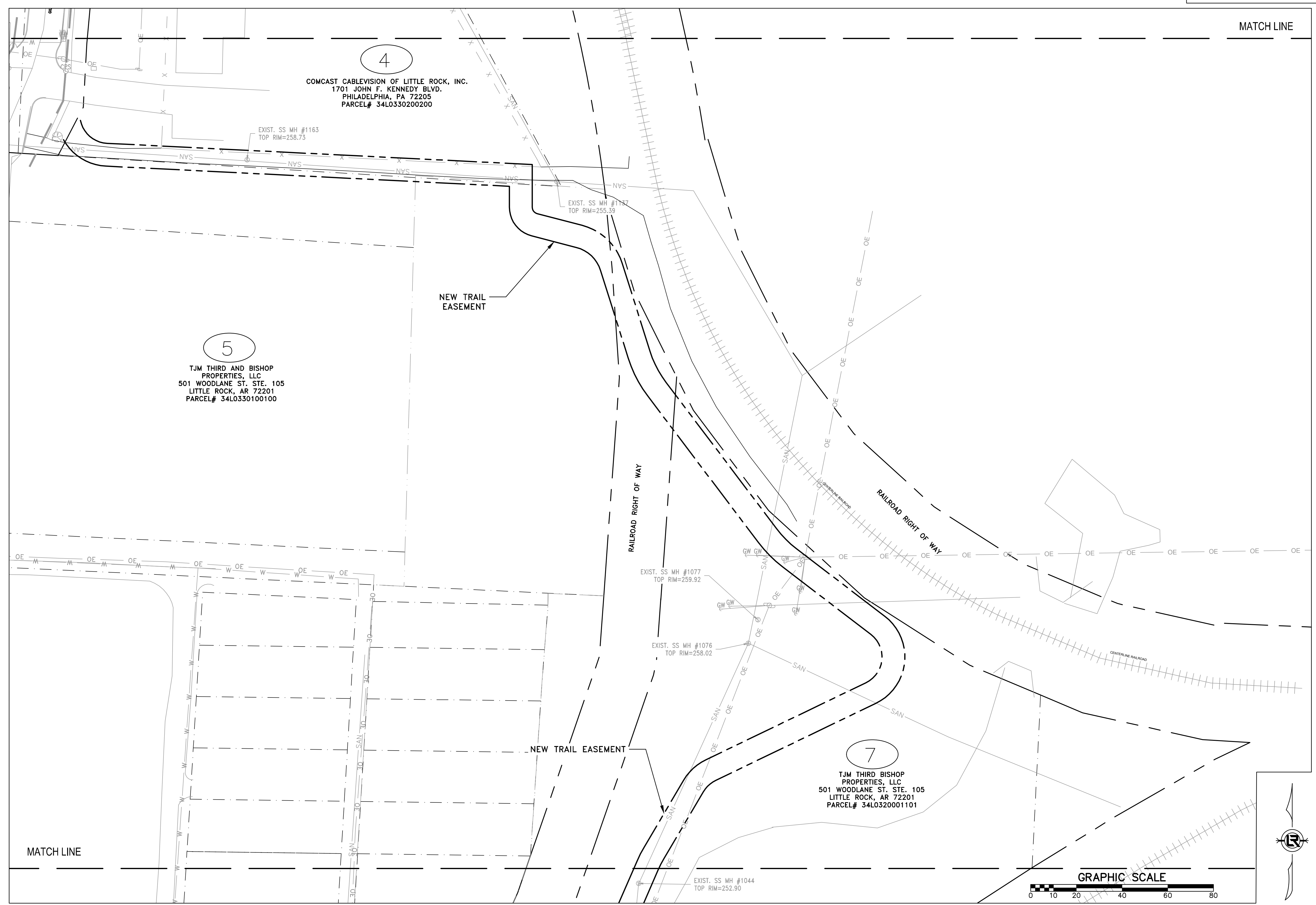

REVISIONS	DATE

CITY OF LITTLE ROCK, ARKANSAS  
 ROSE CREEK TRAIL  
 OWNERSHIP MAP SHEET 3

DEPARTMENT OF PUBLIC WORKS  
 CIVIL ENGINEERING  
 701 W. MARKHAM  
 LITTLE ROCK, ARKANSAS 72201

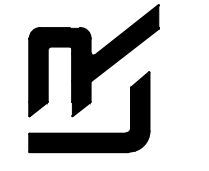

DRAWN BY  
 AS  
 DESIGNED  
 AT  
 CHECKED  
 BAP  
 DATE  
 02-19-2024  
 SCALE  
 H: 1"=20'  
 V: 1"=40'  
 PROJECT NO.  
 SHEET NO.  
 03

MATCH LINE

